

22260518	<b>DATA SHEET</b>	
Valid from: 12.09.2019	<b>AB-C3-M12Y-(L*)PUR-M8FA</b>	

## Product description

Sensor/actuator cable, 3-pos., PUR black, straight  
Y-plug M12 on 2x angled socket M8.



## Product variations

Article number	Article description	Length (L*) [m]
22260518	AB-C3-M12Y-0,3PUR-M8FA	0.3
22260519	AB-C3-M12Y-0,6PUR-M8FA	0.6
22260520	AB-C3-M12Y-1,0PUR-M8FA	1.0
22260521	AB-C3-M12Y-2,0PUR-M8FA	2.0

This datasheet is also valid for other length configurations. Other lengths upon request.

## M8 connector

### General properties

Coding	A
Protection degree	IP65/IP67/IP68
Number of contacts	3
Ambient temperature	-25 °C to +90 °C
Rated voltage	60 V
Rated current	4 A
Insulation resistance	≥ 100 MΩ
Contact resistance	≤ 5 mΩ
Overvoltage category	II
Pollution degree	3
Tightening torque	0.2 Nm
Mating cycles	100

### Materials

Contact carrier	TPU GF
Contact carrier, inflammability class in accordance with UL 94	HB
Material, contacts	CuSn
Contact surface	Ni/Au
Material, grip body	TPU
Material, knurl	zinc die-cast, nickel-plated
Material, sealing	NBR

Creator: MANA2/PDP Released: IVSE1/PDP	Document: DB22260518EN Version: 07	Page 1 of 3
---	---------------------------------------	-------------

22260518	<b>DATA SHEET</b>	
Valid from: 12.09.2019	<b>AB-C3-M12Y-(L*)PUR-M8FA</b>	

## M12Y connector

### General properties

Coding	A
Protection degree	IP65/IP67/IP68
Number of contacts	3
Ambient temperature	-25 °C to +90 °C
Rated voltage	60 V
Rated current	4 A
Insulation resistance	≥ 100 MΩ
Volume resistance	≤ 5 mΩ
Overvoltage category	II
Pollution degree	3
Tightening torque	0.4 Nm
Mating cycles	100

### Materials

Contact carrier	TPU GF
Contact carrier, inflammability class in accordance with UL 94	HB
Material, contacts	CuSn
Contact surface	Ni/Au
Material, grip body	TPU
Material, knurl	zinc die-cast, nickel-plated
Material, sealing	NBR

### Cable

Signal line, construction	32 x 0.10 mm
Signal line, AWG	24
Conductor, material	stranded of bare copper wire
Conductor, cross-section	0.25 mm <sup>2</sup>
Number of cores	3
Core identification code	brown (1), blue (2), black (4)
Outer diameter, core insulation	1.17 mm
Core insulation, material	PP
Outer sheath	PUR
Outer sheath, colour	black similar to RAL 9005
Outer diameter, cable	4.4 mm
Ambient temperature, fixed installation	-40 °C to +80 °C
Ambient temperature, flexing	-25 °C to +80 °C
Minimum bending radius, fixed installation	5 x cable diameter
Minimum bending radius, flexing	10 x cable diameter
Travel length	10 m
Travel speed	3 m/s
Acceleration	10 m/s <sup>2</sup>
Number of bending cycles	4.000.000
Nominal voltage	≤ 300 V
Test voltage	≥ 3000 V

Flame retardance	flame retardant acc. to UL-Style 20549
Halogen free	halogen free acc. to DIN VDE 0472 Part 815
Oil resistance	oil resistant acc. to DIN EN 60811-2-1

Creator: MANA2/PDP Released: IVSE1/PDP	Document: DB22260518EN Version: 07	Page 2 of 3
---	---------------------------------------	-------------

22260518	<b>DATA SHEET</b>	
Valid from: 12.09.2019	<b>AB-C3-M12Y-(L*)PUR-M8FA</b>	

Other resistances

resistant to hydrolysis and microbes  
 good resistant to acids, lyes and solvents  
 resistant to sea water  
 limited UV resistance acc. to DIN EN ISO 4892-2-A

### Standards/Approvals

Product standard, M8 connector  
 Product standard, M12 connector  
 UL-listed, E-File

IEC 61076-2-104  
 IEC 61076-2-101  
 E249137

### Drawings

Dimensioned drawing, M12Y connector

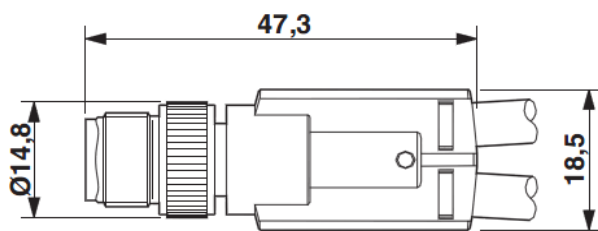

Dimensioned drawing, M8 connector

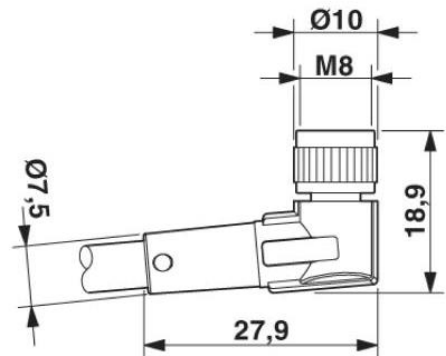

Pin assignment

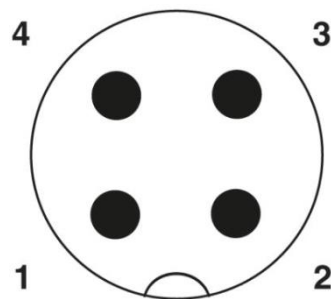

Cable

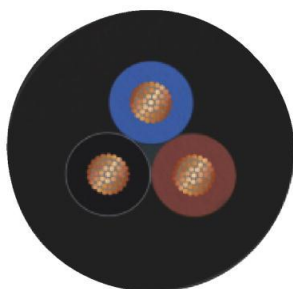

Core identification code: brown (1), blue (2), black (4)

Pin assignment

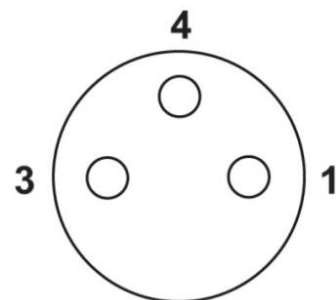

Wiring diagram

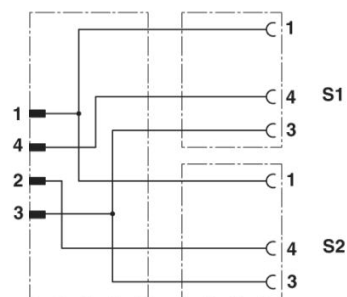

### Application range

Automation, industrial machinery and plant engineering

### Note

Photographs are not true to scale and do not represent detailed images of the respective products.

Creator: MANA2/PDP Released: IVSE1/PDP	Document: DB22260518EN Version: 07	Page 3 of 3
---	---------------------------------------	-------------