

22260223	DATA SHEET	
Valid from: 08.12.2020	AB-C3-M12MA-(L*)PUR	

Product description

Sensor/actuator cable, 3-pos., PUR black, angled plug
M12 on free conductor end.



Product variations

Article number	Article description	Length (L*) [m]
22260223	AB-C3-M12MA-2,0PUR	2
22260224	AB-C3-M12MA-5,0PUR	5
22260256	AB-C3-M12MA-10,0PUR	10

This datasheet is also valid for other length configurations. Other lengths upon request.

M12 connector

General properties

Coding	A
Protection degree	IP65/IP67/IP68
Number of contacts	3
Ambient temperature	-25 °C to +90 °C
Rated voltage	250 V
Rated current	4 A
Insulation resistance	≥ 100 MΩ
Contact resistance	≤ 5 mΩ
Overvoltage category	II
Pollution degree	3
Tightening torque	0.4 Nm
Mating cycles	100

Materials

Contact carrier	TPU GF
Contact carrier, inflammability class in accordance with UL 94	HB
Material, contacts	CuSn
Contact surface	Ni/Au
Material, grip body	TPU
Material, knurl	zinc die-cast, nickel-plated
Material, sealing	NBR

Creator: MANA2/PDP Released: IVSE1/PDP	Document: DB22260223EN Version: 08	Page 1 of 3
---	---------------------------------------	-------------

We reserve all rights according to DIN ISO 16016.

PD 0019/05_04.18EN

22260223	DATA SHEET	
Valid from: 08.12.2020	AB-C3-M12MA-(L*)PUR	

Cable

Signal line, construction	42 x 0.10 mm
Signal line, AWG	22
Conductor, material	stranded of bare copper wire
Conductor, cross-section	0.34 mm ²
Number of cores	3
Core identification code	brown (1), blue (3), black (4)
Outer diameter, core insulation	1.27 mm
Core insulation, material	PP
Outer sheath	PUR
Outer sheath, color	grey-black similar to RAL 7021
Outer diameter, cable	4.4 mm
Ambient temperature, fixed installation	-40 °C to +80 °C
Ambient temperature, flexing	-5 °C to +80 °C
Minimum bending radius	44 mm
Travel length	10 m
Travel speed	3 m/s
Travel Acceleration	10m/s ²
Number of bending cycles	4.000.000
Nominal voltage	≤ 300 V
Test voltage	≥ 3000 V
Other resistances	resistant to hydrolysis and microbes good resistant to acids, lyes and solvents limited UV resistance acc. to DIN EN ISO 4892-2-A
Flame resistance	acc. to UL-Style 20549
Halogen free	acc. to DIN VDE 0472 part 815
Oil resistance	acc. to DIN EN 60811-2-1

Standards/Approvals

Product standard, M12 connector	IEC 61076-2-101
UL-listed, E-File	E249137

Creator: MANA2/PDP Released: IVSE1/PDP	Document: DB22260223EN Version: 08	Page 2 of 3
---	---------------------------------------	-------------

22260223	DATA SHEET	
Valid from: 08.12.2020	AB-C3-M12MA-(L*)PUR	

Drawings

Dimensioned drawing, M12 connector

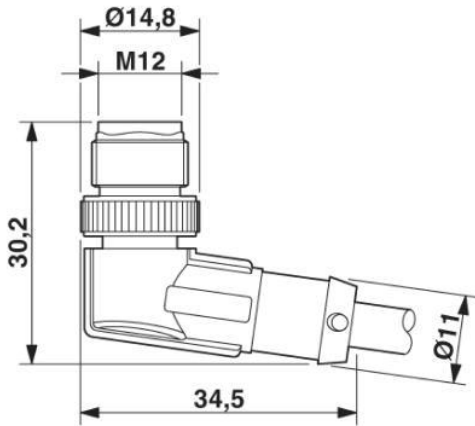

Wiring diagram

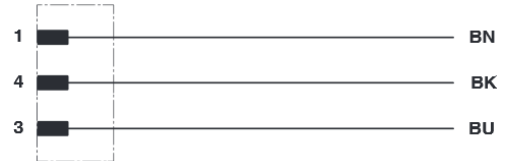

Pin assignment

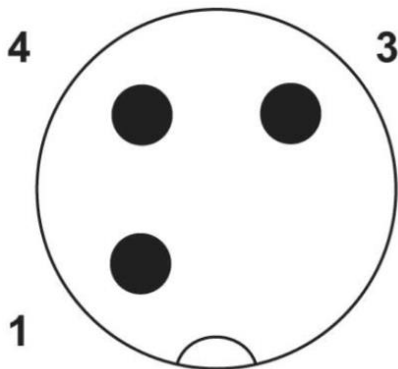

Cable

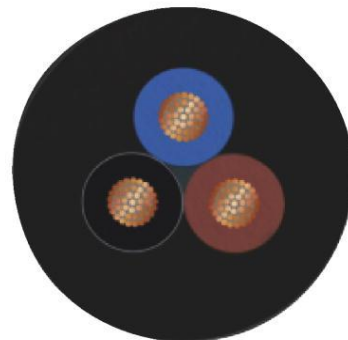

Core identification code: brown (1), blue (3), black (4)

Application range

Automation, industrial machinery and plant engineering

Note

Photographs are not true to scale and do not represent detailed images of the respective products.

Creator: MANA2/PDP Released: IVSE1/PDP	Document: DB22260223EN Version: 08	Page 3 of 3
---	---------------------------------------	-------------