

21700600	DATA SHEET	
Valid from: 08.07.2021	ED-IE-AX-6A-A-20-FC	

Product description

- Field mountable Industrial Ethernet RJ45 connector with color coding acc. to T568A
- Connector acc. to IEC 60603-7-51
- Suitable for industrial applications, structured cabling for office building applications, data centers and home networks



General properties

Ambient temperature	-40 to +85 °C
Protection degree	IP 20
Outer diameter, cable	5.0 – 9.0 mm
Outer diameter, wire	1.0 – 1.6 mm
Termination cross section, stranded, 7 wires	AWG27/7 – AWG22/7
Termination cross section, solid	AWG24/1 – AWG22/1

Mechanical properties

Insertion force	≤ 30 N
Mating cycles	≥ 750
Cable extraction force (assembled connector)	≥ 50 N

Electrical properties

Contact resistance	≤ 20 mΩ
Insulation resistance	≥ 500 MΩ
Proof voltage, contact-contact	≥ 1000 V, DC
Proof voltage, contact-shield	≥ 1500 V, DC
Current carrying capacity at 50 °C	1 A
Suitable for Power over Ethernet 4PPoE acc. to IEEE 802.3bt	yes

Transmission properties

Suitable for 10 Gigabit Ethernet acc. to IEEE 802.3an	yes
Category 6 _A	ISO/IEC 11801; DIN EN 50173-1
Class E _A	ISO/IEC 11801; DIN EN 50173-1
Category 6A	ANSI/EIA-568.2-D

Materials

Connector housing, base material	die-cast zinc
Connector housing, surface	Ni
Contacts, surface	Au

Standards

Product standard	RJ45 connector acc. to IEC 60603-7-51
Generic cable systems	ANSI/TIA/EIA-568.2-D ISO/IEC 11801 / DIN EN 50173-1

Creator: MANA2/PDP Released: IVSE1/PDP	Document: DB21700600EN Version: 04	Page 1 of 2
---	---------------------------------------	-------------

21700600	DATA SHEET	
Valid from: 08.07.2021	ED-IE-AX-6A-A-20-FC	

Approvals

UL listed, E-File

E353543

Drawings

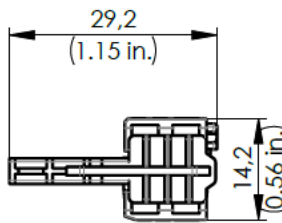
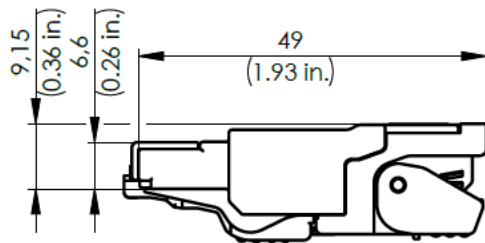

Anschlussbelegung / PIN assignment T568A
nach / according to TIA-568.2-D

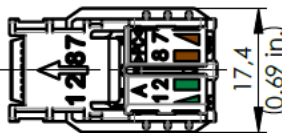
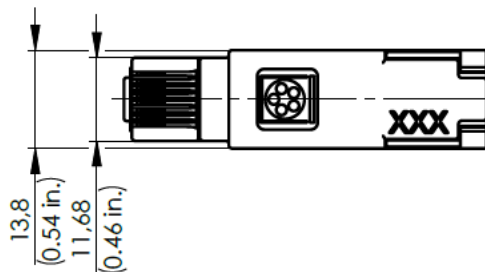
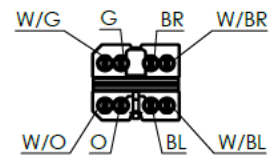

Anschlussbelegung / PIN assignment T568B
nach / according to TIA-568.2-D

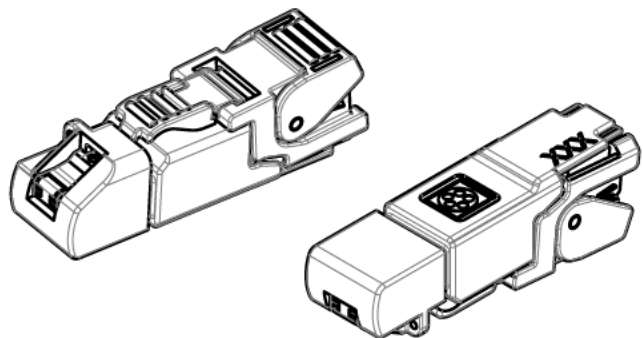
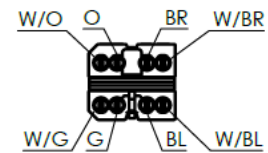

Application range

Automation, industrial machinery and plant engineering

Note

Photographs are not true to scale and do not represent detailed images of the respective products.

Creator: MANA2/PDP Released: IVSE1/PDP	Document: DB21700600EN Version: 04	Page 2 of 2
---	---------------------------------------	-------------