

75009738	DATA SHEET	
Valid from: 25.02.2019	EPIC® ULTRA Kit H-B 10 SP TS LB 11-21	

Description

- Optimally matched components.
- H-BE inserts with push-in termination up to 2.5 mm² connection cross-section.
- The possibility of using higher voltages and currents as well as high reliability characterizes the EPIC® H-BE series.
- EPIC® ULTRA housings are universally applicable due to their high corrosion resistance and high protection against environmental influences.
- Reduced order costs. No wrong orders.

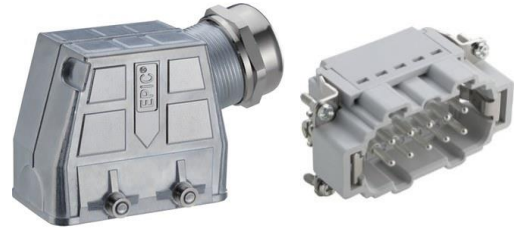

Components

Item number of the combination	75009738
Housing	EPIC® ULTRA H-B 10 TS QB 11-21 BRUSH (70250212)
Insert	EPIC® H-BE 10 SP (44423202)

General characteristics

Insert	H-BE 10
Gender	Male
Connection type	Push-in
Connection cross-section	0.14 – 2.5 mm ²
Number of contacts	10 + PE
Contact diameter	2,5 mm
Mating cycles	500
Temperature range	-40°C to +100°C, short-term up to +125 °C
Housing	Hood
Cable entry	1x lateral
Cable gland	Yes
Clamping range	11-21 mm
Screen contacting	BRUSH
Diameter above cable braiding	min. 6 mm
Locking	Bolt for double lever
Protection (DIN EN 60529)	IP 68 (mated and latched)
Protection (NEMA 250/UL50E)	4, 4X and 12 (mated and latched)

Electrical characteristics

Rated voltage, IEC	500 V
Rated impulse voltage	6 kV
Rated current, IEC	16 A
Contact resistance	< 3 mOhm
Degree of soiling	3

Materials/Surfaces

Contacts	Copper alloy, hard silver plated
Insulating body	PA
Flammability class according to UL94	V0

Creator: BEGE1/PDP Released: IVSE1/PDP	Dokument: DB 75009738EN Version: 02	Page 1 of 3
---	--	-------------

75009738	DATA SHEET	
Valid from: 25.02.2019	EPIC® ULTRA Kit H-B 10 SP TS LB 11-21	

Housing	Zinc die cast, nickel plated
Locking	Stainless steel
Housing seal	-
Cable gland	Brass, nickel plated
Insert	PA
Seal ring	CR

Standards

Safety standards	IEC 61984
Product features according to	DIN EN 6988
	DIN EN ISO 9227, method NSS, duration 480h
	DIN EN 60068-2-52, severity level 2

Technical drawings

Housing dimensions

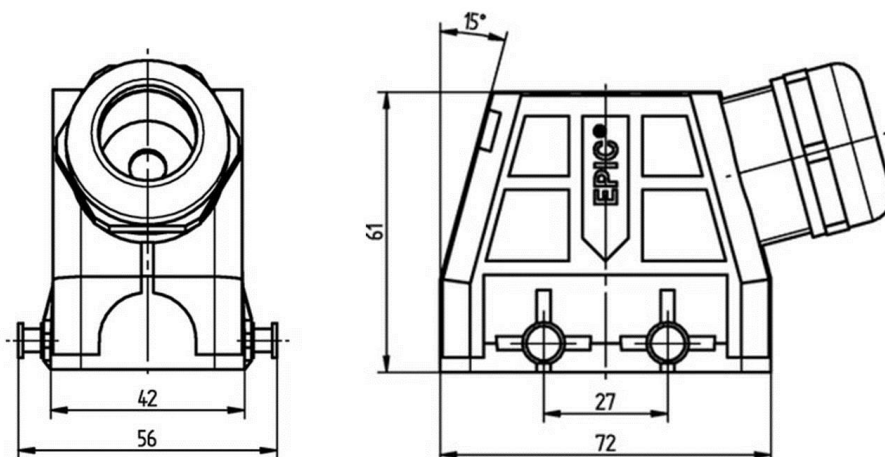

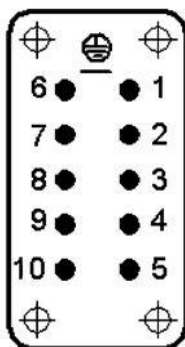

Insert
Pin assignment

M

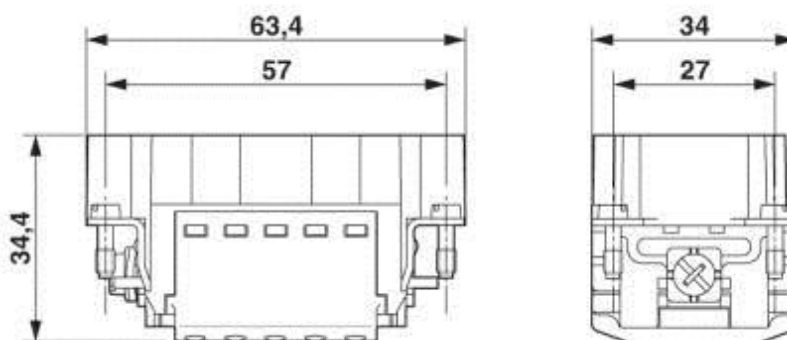

Dimensions



75009738	DATA SHEET	
Valid from: 25.02.2019	EPIC® ULTRA Kit H-B 10 SP TS LB 11-21	



Good chemical resistance



Large clamping range



Corrosion resistant



Installation time

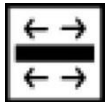

Optimal strain relief



Required space



Robust



SKINTOP® Integrated Cable Gland



Connectors with standart housing



Waterproof



Temperature resistant

Info

EMC protection, corrosion-resistant, SKINTOP® integrated cable gland
Multifunctional insert for versatile applications

Application range

In EMC-sensitive environments, for fixed and flexible applications (e.g. machiner, wind turbines), construction machinery, electric motor manufacturing

Remark

Photographs are not to scale and do not represent detailed images of the respective products.

Creator: BEGE1/PDP Released: IVSE1/PDP	Dokument: DB 75009738EN Version: 02	Page 3 of 3
---	--	-------------