

44420288	DATA SHEET	
Valid from: 14.01.2019	EPIC® POWERLOCK BOX C	

Description

- Circular connectors for servomotors and power supply
- Guarantees the correct sequence is followed when connecting and disconnecting a set of connectors (PE, N, L1, L2, L3)
- Every colour has a different coding to prevent incorrect plugging
- IP 20 finger-protected
- Integrated micro-switch that can be connected to circuit breaker or alarm circuit



General Characteristics

Series	Powerlock Box C
Version	panel- mount base, drain / source
Rated voltage (V)	1000 V
Rated current (A)	Crimp terminated: max. 660 A
Contacts	Crimp termination: copper, silver-plated
Number of contacts	4+PE
Termination methods	Crimp termination: 35 - 240 mm ²
Protection	IP 65 (latched)
Cycle of mechanical operation	500
Temperature range	-25°C to +85°C
Degree of soiling	3

Product Variations

Article- Number	Article	Fastening type	Pin configuration
POWERLOCK BOX A1, panel-mount base, drain with M12 threaded post			
44420288	POWERLOCK BOX A1 C	Ø6,5mm (4x)	4+PE
POWERLOCK BOX A1, panel-mount base with cover, drain with M12 threaded post			
44420289	POWERLOCK BOX A1 CD	Ø6,5mm (4x)	4+PE
POWERLOCK BOX A6, panel-mount base, source with M12 threaded post			
44420284	POWERLOCK BOX A6 C	Ø6,5mm (4x)	4+PE
POWERLOCK BOX A6, panel-mount base with cover, source with M12 threaded post			
44420285	POWERLOCK BOX A6 CD	Ø6,5mm (4x)	4+PE

Material/Surface

Housing High temperature thermoplastic

Approvals

VDE-Approval, VDE-REG.-No. D042

Creator: STKU3/PDP Released: IVSE1/PDP	Document: DB44420288EN Version: 03	Page 1 of 5
---	---------------------------------------	-------------

44420288	DATA SHEET	
Valid from: 14.01.2019	EPIC® POWERLOCK BOX C	

Technical Drawings

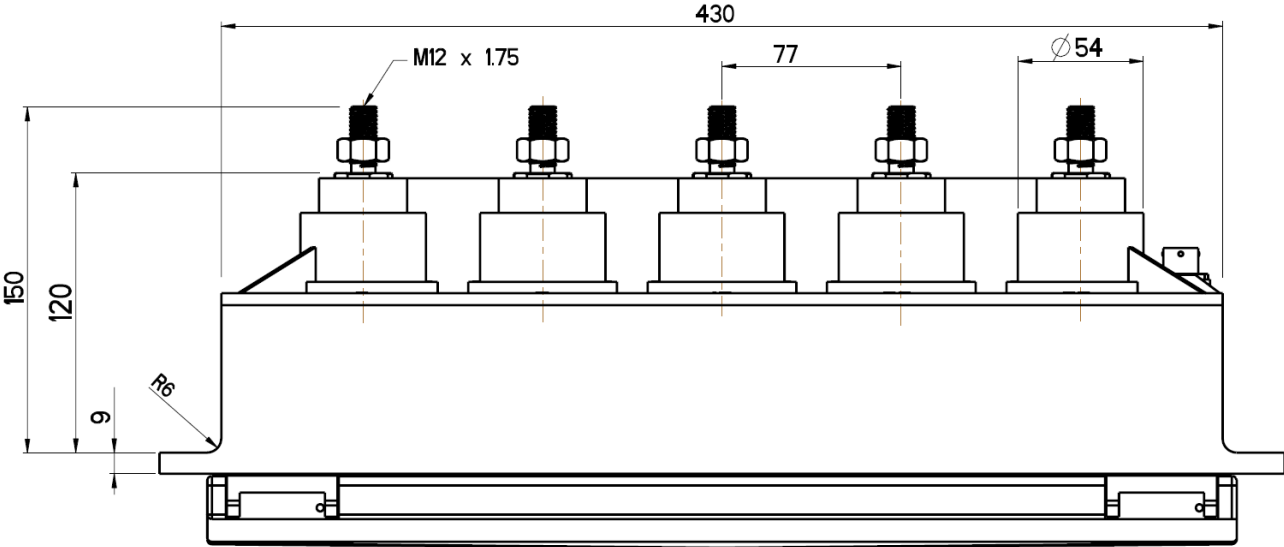

44420288	DATA SHEET	
Valid from: 14.01.2019	EPIC® POWERLOCK BOX C	

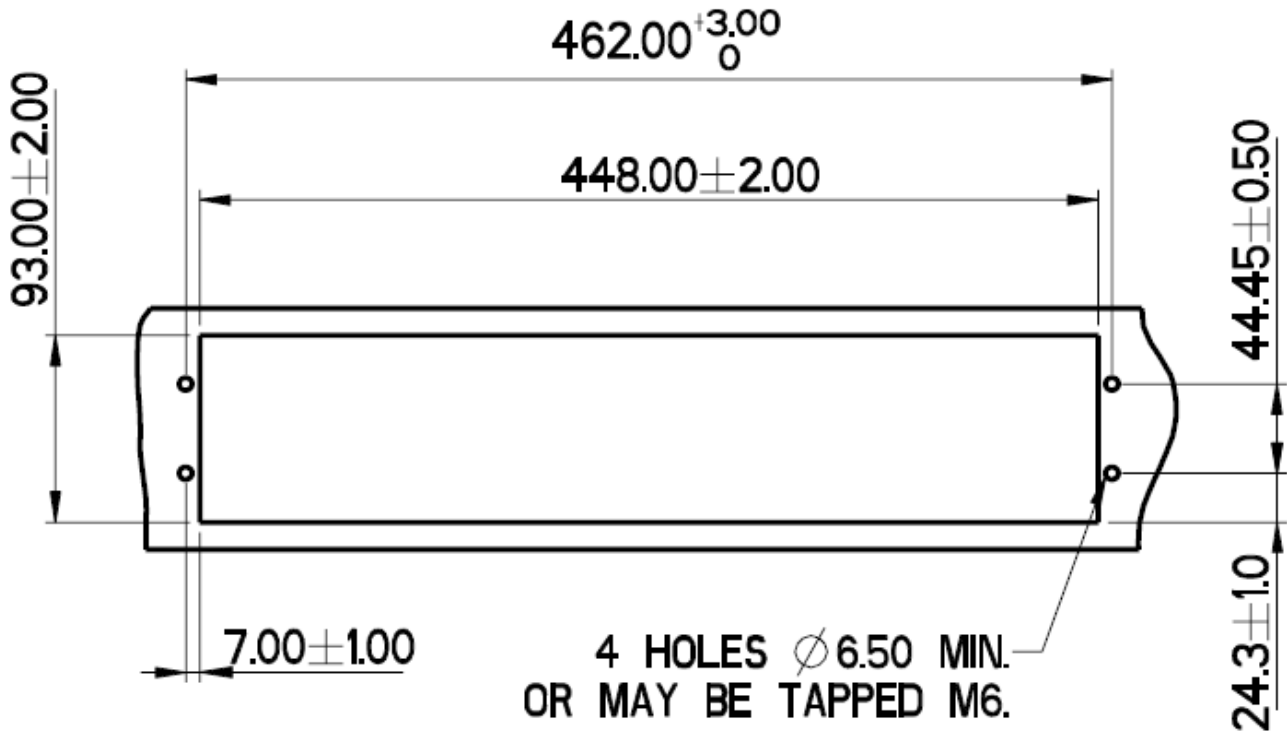



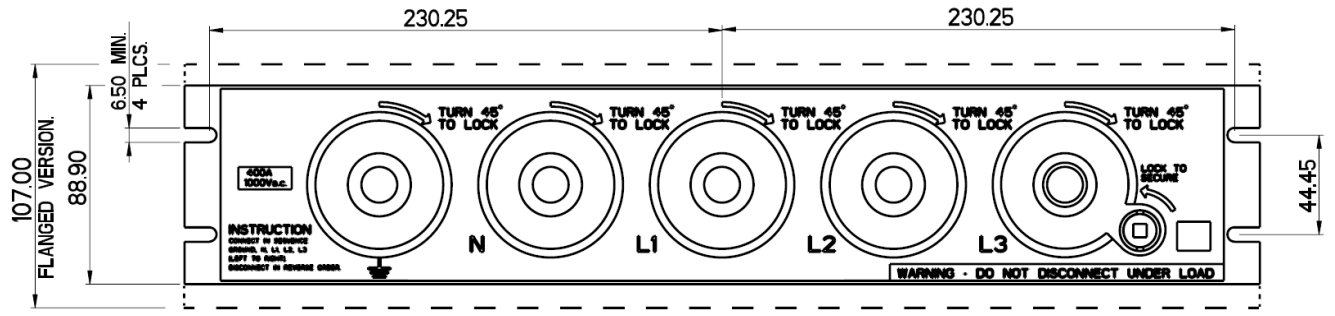



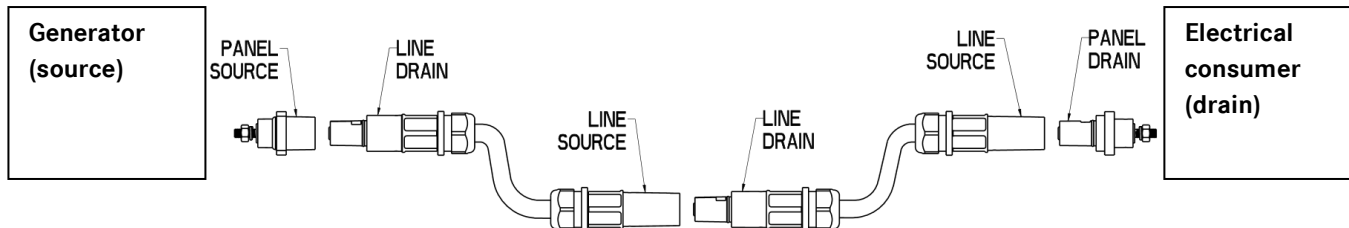

**RECOMMENDED PANEL CUT OUT.
FOR FLANGED VERSION**

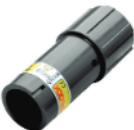

We reserve all rights according to DIN ISO 16016.
PD 0019/05_04.18EN

System description



	Line connector	Panel mount connector	Crimp contact	Screw contact
Source	D6 	A6 		
Drain	F6 	A1 		

Step 1) Selection of housings:

Step 2) Selection of SKINTOP® cable gland M40 for the housing (only cable connectors):

e.g. 3111250 (black), 53111450 (light grey), 53111050 (silver grey)

Step 3) Decision: 400 A / max. 120mm² → Screw contacts

660 A / max. 240mm² → Crimp contacts

! Screw and crimp contacts are not allowed to be mixed!

Step 4) Selection of contacts:

Contacts with M12 thread (for cable lug Ø12 mm)

	M12-thread 660 A	M12-thread 400 A
Source	 44420261	 44420242
Drain	 44420260	 44420241

Note: POWERLOCK Boxes: Already includes contacts with M12 thread.

Tightening torque M12 nut: 27,5 Nm - 31,4 Nm

44420288	DATA SHEET	
Valid from: 14.01.2019	EPIC® POWERLOCK BOX C	



Approved



Robust



Reliability



Waterproof

Info

Can be locked to prevent unauthorised disconnection

Application range

Alternative energy installations

For mobile and stationary power distribution

For the connection of motors, transformers and generators

Light & sound technology

Housings

Sealed security lid is optional

Product features

Included: Contacts with M12 threaded post

Cable connector for microswitch optional

19" housing with height unit 2HE/2U

Remark

* Trade product, not Lapp product

Photographs are not to scale and do not represent detailed images of the respective products.

Creator: STKU3/PDP Released: IVSE1/PDP	Document: DB44420288EN Version: 03	Page 5 of 5
---	---------------------------------------	-------------