

54115200	DATA SHEET	
Valid from: 02.12.2021	SKINTOP® K-M / KR-M ATEX plus	

The SKINTOP® K-M / KR-M ATEX *plus* is a special cable gland, based of polyamide. It is designed particularly for the use in electrical equipment in areas with risk of explosion, which require class "e" security (DIN EN 60079-0, DIN EN 60079-7, DIN EN 60079-31, IEC60079-0, IEC 60079-7, IEC 60079-31).



Components:

Gland body	Polyamide
Cap nut	Polyamide
Sealing ring	CR
O-ring:	NBR

Technical features:

Connecting thread	M12x1.5 up to M63x1.5 acc. to EN 60423
Functional thread	Multi-start trapezoidal thread
Protection class	IP66 acc. to EN 60529 IP68 – 10 bar, test acc. to EN 60529
Temperature range	-20 °C up to +80 °C
Design	K-M standard KR-M with reducing sealing ring (for smaller cable diameters)
Colour	RAL 9005 black, UV resistant

Approvals:



EC Type Examination Certification:	IBExU 08 ATEX 1063x
IECEx Certificate:	IECEx IBE 13.0027x

Norm references:



Creator: V. Charcenko /PDP Released: DAMU1/PDP	Document: DB54115200EN Version: 12	Page 1 of 2
---	---------------------------------------	-------------

54115200	DATA SHEET	
Valid from: 02.12.2021	SKINTOP® K-M / KR-M ATEX plus	

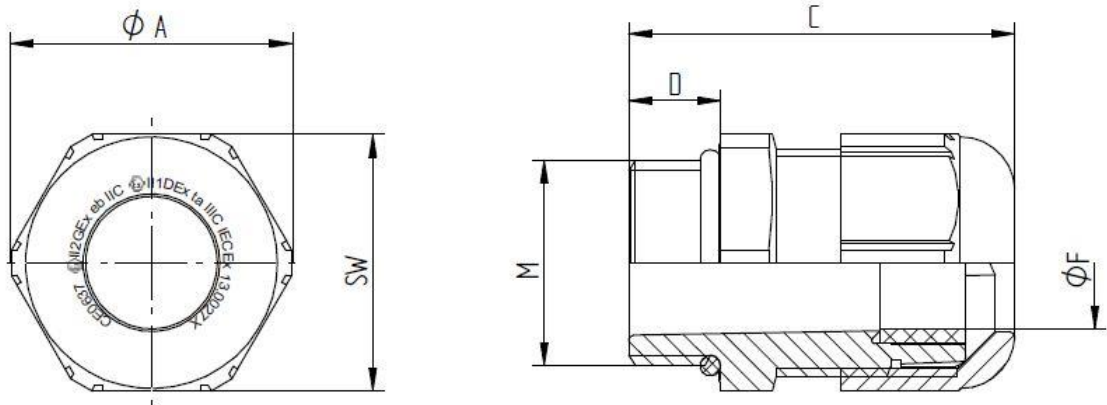

SKINTOP® K-M ATEX plus

M	SW [mm]	Ø A [mm]	C [mm]		D [mm]	Ø F [mm] Clamping range	Article No.
			min.	max.			
M12x1,5	15	16,6	26,5	30,0	8	3-5,5	54115200
M16x1,5	19	21,1	29,0	34,0	8	7-9	54115210
M20x1,5	25	27,6	34,0	38,0	9	7-13	54115220
M25x1,5	30	33,6	35,0	40,0	10	11-17	54115230
M32x1,5	36	40,3	39,0	47,0	10	12-21	54115240
M40x1,5	46	51,6	43,0	52,0	10	19-28	54115250
M50x1,5	55	61,6	54,0	62,0	12	27-35	54115260
M63x1,5	66	73,9	59,0	71,0	12	37-45	54115270

SKINTOP® KR-M ATEX plus

M	SW [mm]	Ø A [mm]	C [mm]		D [mm]	Ø F [mm] Clamping range	Article No.
			min.	max.			
M12x1,5	15	16,6	26,5	30,0	8	2-4	54115205
M16x1,5	19	21,1	29,0	34,0	8	4-6	54115215
M20x1,5	25	27,6	34,0	38,0	9	5-10	54115225
M25x1,5	30	33,6	35,0	40,0	10	6-13	54115235
M32x1,5	36	40,3	39,0	47,0	10	9-15	54115245
M40x1,5	46	51,6	43,0	52,0	10	16-23	54115255
M50x1,5	55	61,6	54,0	62,0	12	22-29	54115265
M63x1,5	66	73,9	59,0	71,0	12	29-39	54115275

For more information please see our current catalogue. Please do not hesitate to contact our laboratory if there are any questions regarding resistance against aggressive agents and special oil.

Creator: V. Charcenko /PDP Released: DAMU1/PDP	Document: DB54115200EN Version: 12	Page 2 of 2
---	---------------------------------------	-------------