

22260522	DATA SHEET	
Valid from: 12.09.2019	AB-C3-M12Y-(L*)PUR-M8FA-2L	

Product description

Sensor/actuator cable, 3-pos., PUR black, straight
Y-plug M12 on 2x angled socket M8, 2 LEDs.



Product variations

Article number	Article description	Length (L*) [m]
22260522	AB-C3-M12Y-0,3PUR-M8FA-2L	0.3
22260523	AB-C3-M12Y-0,6PUR-M8FA-2L	0.6
22260524	AB-C3-M12Y-1,0PUR-M8FA-2L	1.0
22260525	AB-C3-M12Y-2,0PUR-M8FA-2L	2.0

This datasheet is also valid for other length configurations. Other lengths upon request.

M8 connector

General properties

Coding	A
Protection degree	IP65/IP67/IP68
Number of contacts	3
Ambient temperature	-25 °C to +90 °C
Rated voltage	24 V
Rated current	4 A
Insulation resistance	≥ 100 MΩ
Contact resistance	≤ 5 mΩ
Overvoltage category	II
Pollution degree	3
Tightening torque	0.2 Nm
Mating cycles	100

Materials

Contact carrier	TPU GF
Contact carrier, inflammability class in accordance with UL 94	HB
Material, contacts	CuSn
Contact surface	Ni/Au
Material, grip body	TPU
Material, knurl	zinc die-cast, nickel-plated
Material, sealing	NBR

Creator: MANA2/PDP Released: IVSE1/PDP	Document: DB22260522EN Version: 05	Page 1 of 3
-------------------------------------------	---------------------------------------	-------------

22260522	DATA SHEET	
Valid from: 12.09.2019	AB-C3-M12Y-(L*)PUR-M8FA-2L	

M12Y connector

General properties

Coding	A
Protection degree	IP65/IP67/IP68
Number of contacts	3
Ambient temperature	-25 °C to +90 °C
Rated voltage	60 V
Rated current	4 A
Insulation resistance	≥ 100 MΩ
Volume resistance	≤ 5 mΩ
Overvoltage category	II
Pollution degree	3
Tightening torque	0.4 Nm
Mating cycles	100

Materials

Contact carrier	TPU GF
Contact carrier, inflammability class in accordance with UL 94	HB
Material, contacts	CuSn
Contact surface	Ni/Au
Material, grip body	TPU
Material, knurl	zinc die-cast, nickel-plated
Material, sealing	NBR

Cable

Signal line, construction	32 x 0.10 mm
Signal line, AWG	24
Conductor, material	stranded of bare copper wire
Conductor, cross-section	0.25 mm ²
Number of cores	3
Core identification code	brown (1), blue (2), black (4)
Outer diameter, core insulation	1.17 mm
Core insulation, material	PP
Outer sheath	PUR
Outer sheath, color	black similar to RAL 9005
Outer diameter, cable	4.4 mm
Ambient temperature, fixed installation	-40 °C to +80 °C
Ambient temperature, flexing	-25 °C to +80 °C
Minimum bending radius, fixed installation	5 x cable diameter
Minimum bending radius, flexing	10 x cable diameter
Travel length	10 m
Travel speed	3 m/s
Acceleration	10 m/s ²
Number of bending cycles	4.000.000
Nominal voltage	≤ 300 V
Test voltage	≥ 3000 V
Flame retardance	flame retardant acc. to UL-Style 20549
Halogen free	halogen free acc. to DIN VDE 0472 Part 815
Oil resistance	oil resistant acc. to DIN EN 60811-2-1

Creator: MANA2/PDP Released: IVSE1/PDP	Document: DB22260522EN Version: 05	Page 2 of 3
-------------------------------------------	---------------------------------------	-------------

22260522	DATA SHEET	
Valid from: 12.09.2019	AB-C3-M12Y-(L*)PUR-M8FA-2L	

Other resistances

resistant to hydrolysis and microbes
 good resistant to acids, lyes and solvents
 resistant to sea water
 limited UV resistance acc. to DIN EN ISO 4892-2-A

Standards/Approvals

Product standard, M8 connector
 Product standard, M12 connector
 UL-listed, E-File

IEC 61076-2-104
 IEC 61076-2-101
 E249137

Drawings

Dimensioned drawing, M12Y connector

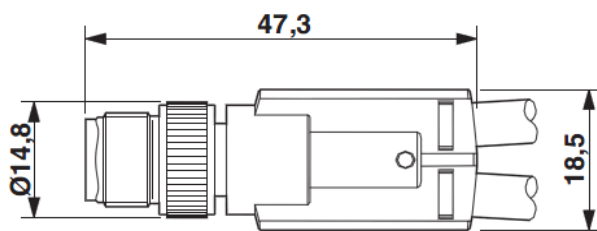

Pin assignment

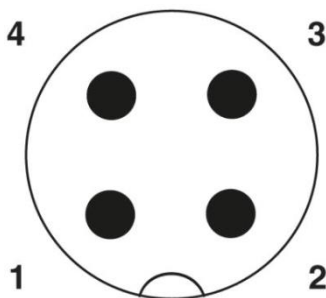

Cable

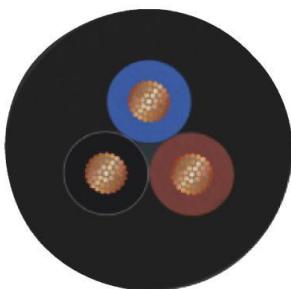

Core identification code: brown (1), blue (2), black (4)

Application range

Automation, industrial machinery and plant engineering

Note

Photographs are not true to scale and do not represent detailed images of the respective products.

Dimensioned drawing, M8 socket

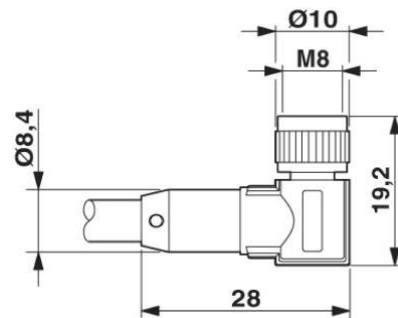

Pin assignment

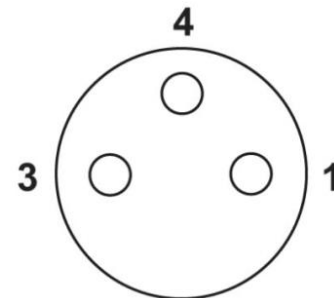

Wiring diagram

