

22260336	DATA SHEET	
Valid from: 12.09.2019	AB-C4-M12MS-(L*)PUR-M12FA-3L	

Product description

Sensor/actuator cable, 4-pos., PUR black, straight plug M12 on angled socket M12, 3 LEDs.



Product variations

Article number	Article description	Length (L*) [m]
22260336	AB-C4-M12MS-0,3PUR-M12FA-3L	0.3
22260337	AB-C4-M12MS-0,6PUR-M12FA-3L	0.6
22260338	AB-C4-M12MS-1,0PUR-M12FA-3L	1.0
22260339	AB-C4-M12MS-2,0PUR-M12FA-3L	2.0

This datasheet is also valid for other length configurations. Other lengths upon request.

M12 connector

General properties

Coding	A
Protection degree	IP65/IP67/IP68
Number of contacts	4
Ambient temperature	-25 °C to +90 °C
Rated voltage	24 V
Rated current	4 A
Insulation resistance	≥ 100 MΩ
Contact resistance	≤ 5 mΩ
Overvoltage category	II
Pollution degree	3
Tightening torque	0.4 Nm
Mating cycles	100

Materials

Contact carrier	TPU GF
Contact carrier, inflammability class in accordance with UL 94	HB
Material, contacts	CuSn
Contact surface	Ni/Au
Material, grip body	TPU
Material, knurl	zinc die-cast, nickel-plated
Material, sealing	NBR

Creator: MANA2/PDP Released: IVSE1/PDP	Document: DB22260336EN Version: 05	Page 1 of 3
---	---------------------------------------	-------------

22260336	DATA SHEET	
Valid from: 12.09.2019	AB-C4-M12MS-(L*)PUR-M12FA-3L	

Cable

Signal line, construction	42 x 0.10 mm
Signal line, AWG	22
Conductor, material	stranded of bare copper wire
Conductor, cross-section	0.34 mm ²
Number of cores	4
Core identification code	brown (1), white (2), blue (3), black (4)
Outer diameter, core insulation	1.27 mm
Core insulation, material	PP
Outer sheath	PUR
Outer sheath, color	grey-black similar to RAL 7021
Outer diameter, cable	4.7 mm
Ambient temperature, fixed installation	-40 °C to +80 °C
Ambient temperature, flexing	-25 °C to +80 °C
Minimum bending radius, fixed installation	5 x cable diameter
Minimum bending radius, flexing	10 x cable diameter
Travel length	10 m
Travel speed	3 m/s
Number of bending cycles	4.000.000
Nominal voltage	≤ 300 V
Test voltage	≥ 3000 V
Flame retardance	flame retardant acc. to UL 758/1581 (horizontal) UL 758/1581 FT2
Halogen free	halogen free acc. to DIN VDE 0472 Part 815 DIN EN 50267-2-1
Oil resistance	oil resistant acc. to DIN EN 60811-2-1 resistant to hydrolysis and microbes good resistant to acids, lyes and solvents
Other resistances	resistant to sea water limited UV resistance acc. to DIN EN ISO 4892-2-A low-adhesion abrasion-resistant

Standards/Approvals

Product standard, M12 connector	IEC 61076-2-101
UL-listed, E-File	E249137

Creator: MANA2/PDP Released: IVSE1/PDP	Document: DB22260336EN Version: 05	Page 2 of 3
---	---------------------------------------	-------------

22260336	DATA SHEET	
Valid from: 12.09.2019	AB-C4-M12MS-(L*)PUR-M12FA-3L	

Drawings

Dimensioned drawing, M12 plug

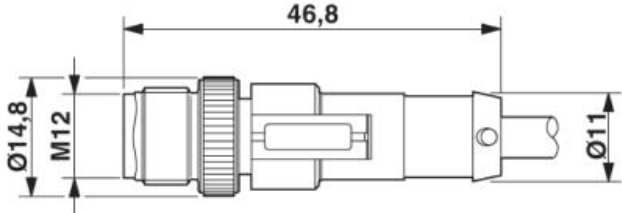

Pin assignment

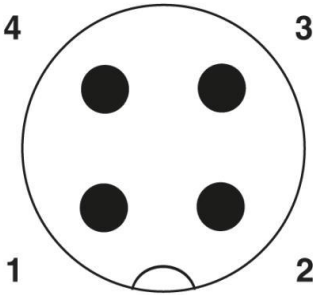

Cable

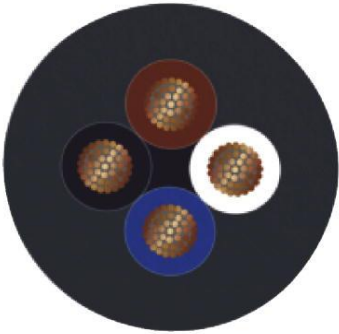

Core identification code: brown (1), white (2), blue (3), black (4)

Application range

Automation, industrial machinery and plant engineering

Note

Photographs are not true to scale and do not represent detailed images of the respective products.

Dimensioned drawing, M12 socket

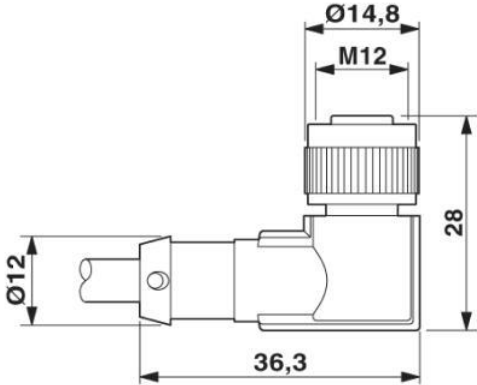

Pin assignment

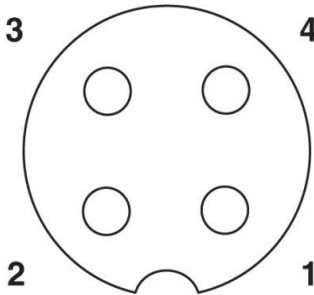

Wiring diagram

