

22260087	<b>DATA SHEET</b>	
Valid from: 17.09.2018	<b>AB-C4-M12MS-PG9-PO-0,5</b>	

## Description

- Sensor/Actuator flush-type plug, 4-pos., A-coded, M12 quick locking
- Front/screw mounting with PG9 thread, can be positioned, with 0.5 m TPE litz wire, 4 x 0.34 mm<sup>2</sup>



## General characteristics

Number of poles	4
Connection type	Fixed connection
Mounting type	Front mounting PG9 with locking nut
Length of cable	0.5 m
Status indicator	No
Coding	A-standard
Degree of protection	IP 67
Ambient temperature (operation)	-25 to +90 °C (-13 to 194 °F) (cable fixed installation) -25 to +85 °C (-13 to 185 °F) (connector)

## Electrical properties

Nominal voltage U <sub>N</sub>	250 V
Nominal current I <sub>N</sub>	4 A
Surge voltage category	II
Pollution degree	3
Insulation resistance (min.)	100 MΩ
Contact resistance (max.)	3 mΩ

## Mechanical properties

### Connector

Contact, material	CuZn
Contact surface, material	Ni/Au
Contact carrier, material	PA66
Knurl, material	Brass (nickel-plated)
Sealing, material	NBR

### Line

Cable type	TPE litz wire
Conductor, material	Tin-plated Cu litz wires
Core insulation, material	TPE
Wire colours	Brown, white, blue, black
Conductor diameter including insulation	1.2 mm ±0.07 mm
Thickness, insulation	0.21 mm
Conductor cross section	0.34 mm <sup>2</sup>
Conductor structure signal line	7 x 0.25 mm
AWG signal line	22
Insulation resistance (min.)	20 MΩ*km
Conductor resistance (max.)	57.6 Ω/km
Nominal voltage, conductor	300 V
Test voltage, conductor	2000 V AC

Creator: MOKO2/PDP Released: IVSE1/PDP	Document: DB22260087EN Version: 01	Page 1 of 2
---	---------------------------------------	-------------

22260087	<b>DATA SHEET</b>	
Valid from: 17.09.2018	<b>AB-C4-M12MS-PG9-PO-0,5</b>	

**Standard**

M12-plug

IEC 61076-2-101

**Technical drawing**

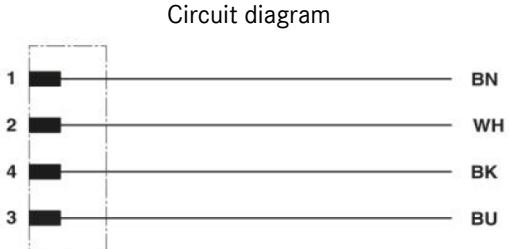
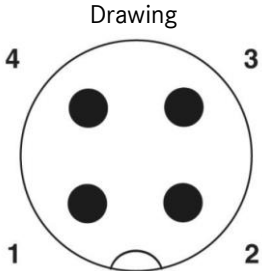
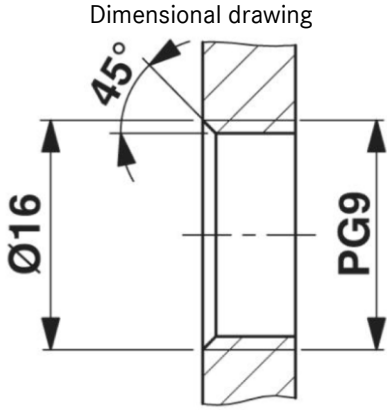
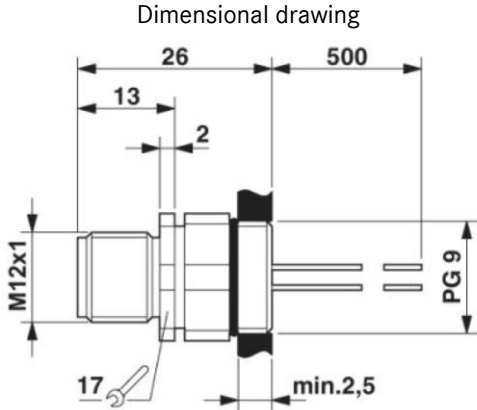

**Application range**

Connection of enclosures and cabinets

**Note**

Photographs are not true to scale and do not represent detailed images of the respective products.

Creator: MOKO2/PDP Released: IVSE1/PDP	Document: DB22260087EN Version: 01	Page 2 of 2
---	---------------------------------------	-------------