

75009703	<b>DATA SHEET</b>	
Valid from: 31.10.2018	<b>EPIC<sup>®</sup> SIGNAL M23 KIT A1 12 PINS SOLDER TERMINATION</b>	

## Description

- Circular connector for servo cables and encoders
- Low-resistance screen contact
- Optimum EMC protection
- Use of high quality materials for increased reliability
- Complete connector with housing and insulation body, equipped with suitable solder contacts

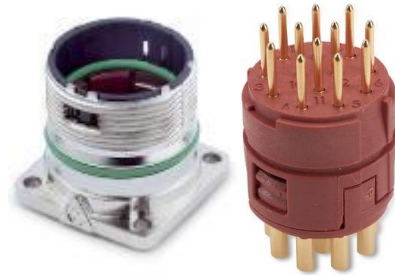

## Components of the combination

Article number of the combination	75009703
Housing	SIGNAL M23 A1 (72004000)
Insert	12 Pin (E-Part) with solder termination (73002720)

## General characteristics

Series	SIGNAL M23
Type	A1, Panel mounted
Version	Male
Connection type	Solder termination
Coding	Black (N)
Pin-arrangement	12 (E-Part)
Contact diameter	1 mm
Termination cross section	Up to 1 mm <sup>2</sup>
Mounting type	Panel mount; through hole for: 4x M 2,5
Degree of protection	IP 68 (10 h / 1 m) (latched)
Cycles of mechanical operation	100
Temperature range	-25 °C to +125 °C

## Materials and surfaces

Housing, base material	Zinc die-cast
Housing, surface	Nickel
Sealing	FPM/FKM
Insert	PA
Contact, base material	Brass
Contact, surface	Gold

## Electrical characteristics

Rated voltage	100 V
Rated impulse voltage	1,5 kV
Rated current	7 A
Contact resistance	< 4 mOhm
Verschmutzungsgrad	3

Creator: STKU3/PDP Released: IVSE1/PDP	Document: DB75009703EN Version: 00	Page 1 of 3
---	---------------------------------------	-------------

75009703	<b>DATA SHEET</b>	
Valid from: 31.10.2018	<b>EPIC<sup>®</sup> SIGNAL M23 KIT A1 12 PINS SOLDER TERMINATION</b>	

### Approvals

VDE-Approval, VDE-REG.-Nr.  
UL File Number

C024  
E249137



### Standards

Safety Standard

IEC 61984; UL 1977

### Technical Drawings

Housing

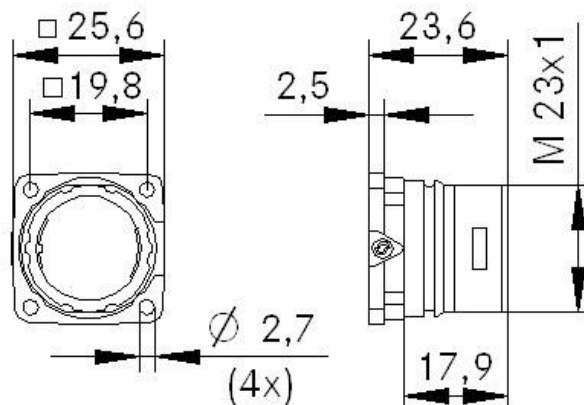

Insert

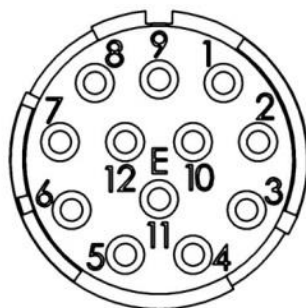

Creator: STKU3/PDP Released: IVSE1/PDP	Document: DB75009703EN Version: 00	Page 2 of 3
---	---------------------------------------	-------------

75009703	<b>DATA SHEET</b>	
Valid from: 31.10.2018	<b>EPIC® SIGNAL M23 KIT A1 12 PINS SOLDER TERMINATION</b>	



Good chemical resistance

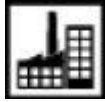

Industrial machinery and plant engineering

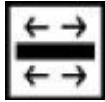

Optimum strain relief



Mechanical resistance



Assembly time



Robust



Integrated SKINTOP® cable gland



Wind energy



Variety of approval certifications

### Info

Robust metal connector with integrated EMC cable gland

### Application range

Plant engineering  
 Servo drives and Servo assemblies  
 Measurement and control technology  
 Apparatus construction

### Remark

Photographs are not to scale and do not represent detailed images of the respective products.

Creator: STKU3/PDP Released: IVSE1/PDP	Document: DB75009703EN Version: 00	Page 3 of 3
---	---------------------------------------	-------------