

75009649	DATA SHEET	
Valid from: 26.02.2019	EPIC® Kit H-BE 16 BS TBF M25	

Description

- Optimally matched components.
- H-BE inserts with screw termination up to 2.5 mm² connection cross-section.
- The possibility of using higher voltages and currents as well as high reliability characterizes the EPIC® H-BE series.
- Reduced order costs. No wrong orders.

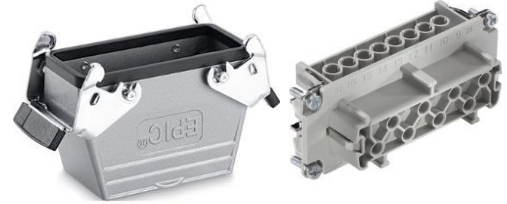

Components

Item number of the combination	75009649
Housing	EPIC® H-B 16 TBF M25 (19086000)
Insert	EPIC® H-BE 16 BS DR (10195000)

General characteristics

Insert	H-BE16
Gender	Female
Connection type	Screw termination
Connection cross-section	0.5 – 2.5 mm ²
Wire protection	Yes
Number of contacts	16 + PE
Contact diameter	2,5 mm
Mating cycles	500
Temperature range	-40°C to +100°C, short-term up to +125 °C
Housing	Cable coupler hood
Gland body	No
Cable entry	1x straight
Locking	Double lever
Protection (DIN EN 60529)	IP 65 (mated and latched)
Protection (NEMA 250/UL50E)	4 and 12 (mated and latched)

Electrical characteristics

Rated voltage, IEC	500 V
Rated voltage, UL	600 V
Rated voltage, CSA	600 V
Rated impulse voltage	6 kV
Rated current, IEC	16 A
Rated current, UL	16 A
Rated current, CSA	16 A
Contact resistance	< 2 mOhm
Degree of soiling	3

Creator: BEGE1/PDP Released: IVSE1/PDP	Dokument: DB75009649EN Version: 02	Page 1 of 3
---	---------------------------------------	-------------

75009649	DATA SHEET	
Valid from: 26.02.2019	EPIC[®] Kit H-BE 16 BS TBF M25	

Materials/Surfaces

Contacts	Copper alloy, hard silver plated
Insulating body	PC
Flammability class according to UL94	V0
Housing	Aluminium alloy, powder-coated (grey)
Locking	Steel, zinc-plated
Housing seal	NBR
Gland body	-

Approvals

VDE-Approval, VDE-REG.-Nr.	B437
UL File Nummer	E75770
CSA File Nummer	053004



Standards

Safety standards IEC 61984; UL 1977; CSA-C22.2

Technical drawings

Housing dimensions

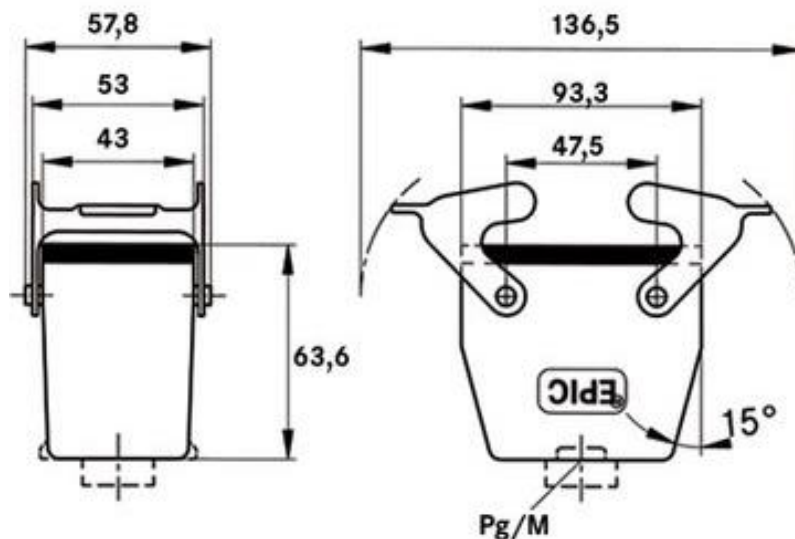

Creator: BEGE1/PDP Released: IVSE1/PDP	Dokument: DB75009649EN Version: 02	Page 2 of 3
---	---------------------------------------	-------------

75009649	DATA SHEET	
Valid from: 26.02.2019	EPIC® Kit H-BE 16 BS TBF M25	

Insert

Pin assignment

Dimensions

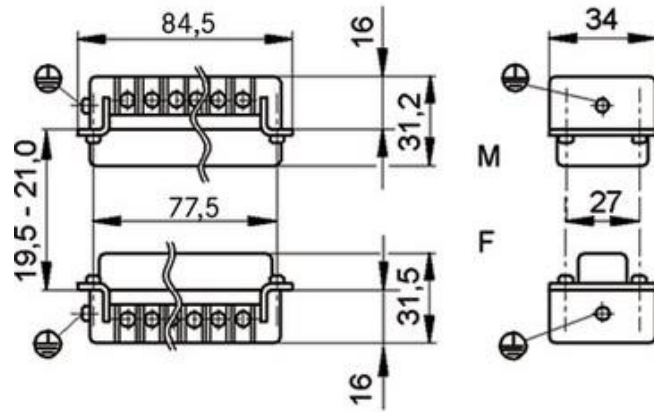
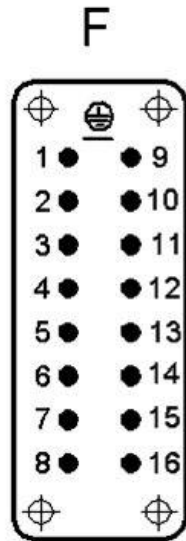

Automation



Industrial machinery and plant engineering



Mechanical resistance



Robust



Waterproof



Temperature-resistant

Info

Universal, robust metal housings

Multifunctional insert for versatile applications

Application range

Plant engineering, control engineering, plastics industry, light & sound technology

Remark

Photographs are not to scale and do not represent detailed images of the respective products.

Creator: BEGE1/PDP Released: IVSE1/PDP	Dokument: DB75009649EN Version: 02	Page 3 of 3
---	---------------------------------------	-------------