

44423070	DATA SHEET	
Valid from: 17.09.2018	EPIC® M17 POWER A1	

Description:

Device connector straight, front wall mounting
 SPEEDCON-Lock, M17
 Pin configuration: 3+PE, 5+PE, 6+PE; 7+PE, 3+PE+5
 Contact type: male/female, crimp
 Seal: O-Ring axial
 Shielded: yes
 Flange dimension: 21, 6 mm x 21, 6 mm



Product variants:

Article Number	Type	Pin configuration	PU
44423075	female	3+PE	5 pieces
44423070	male	3+PE	5 pieces
44423076	female	5+PE	5 pieces
44423071	male	5+PE	5 pieces
44423077	female	6+PE	5 pieces
44423072	male	6+PE	5 pieces
44423078	female	7+PE	5 pieces
44423073	male	7+PE	5 pieces
44423079	female	3+PE+5	5 pieces
44423074	male	3+PE+5	5 pieces

General Characteristics

Connector Type	Device connector
Pin configuration	3+PE; 5+PE; 6+PE; 7+PE; 3+PE+5
Connector locking system	Speedcon
Mounting type	front wall mounting: 4 x Ø 2,7 mm
Termination method	Crimp
upper temperature range	+ 125 °C
lower temperature range	- 40 °C
Material contact	CuZn (brass)
Contact surface	Au (Gold)
Material insert	PA
Material housing	Zinc die-casting, nickel-plated
Seal	FPM
Protection class	IP 67
Degree of soiling	3
Overvoltage category	III
Cycle of mechanical operation	>100

Creator: STKU3/PDP Released: IVSE1/PDP	Document: DE44423070EN Version: 01	Page 1 of 7
---	---------------------------------------	-------------

Version 3+PE

Electrical Characteristics:

Rated Voltage	630 V
Rated Impulse Voltage	6000 V
Rated Current (25°C)	20 A
Contact diameter	2 mm
Termination cross-section	0,25 mm ² – 2,5 mm ²

Pin configuration:

Female

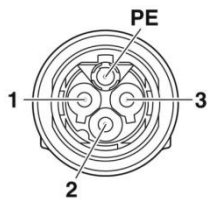

Male

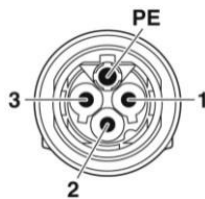

Derating:

Diagramm

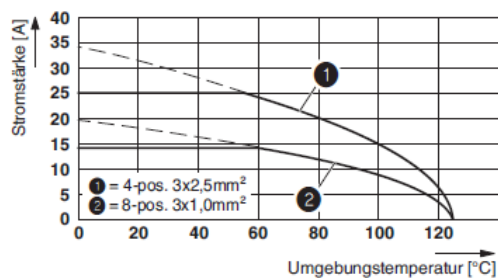

Attenuation:

Diagramm

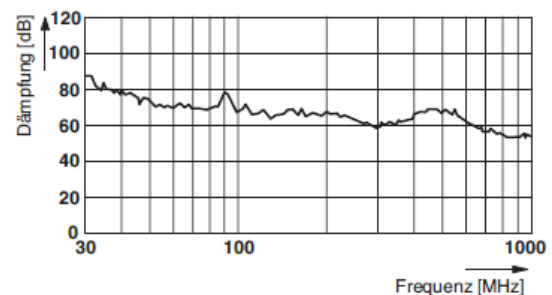

Suitable female contacts (contacts order separately)



Lapp Art. No. Description

44423120:	Crimpkontakt, machined, Contact diameter: 2 mm, Crimp range: 0,25 mm ² ...1 mm ²
44423121:	Crimpkontakt, machined, Contact diameter: 2 mm, Crimp range: 1 mm ² ...2,5 mm ²

Suitable male contacts (contacts order separately)



Lapp Art. No. Description

44423128:	Crimpkontakt, machined, Contact diameter: 2 mm, Crimp range: 0,25 mm ² ...1 mm ²
44423129:	Crimpkontakt, machined, Contact diameter: 2 mm, Crimp range: 1 mm ² ...2,5 mm ²

Version 5+PE

Electrical Characteristics:

Rated Voltage	630 V
Rated Impulse Voltage	6000 V
Rated Current (25°C)	14 A
Contact diameter	1 mm
Termination cross-section	0,06 mm ² – 1,0 mm ²

Pin configuration:

Female



Male



Derating:

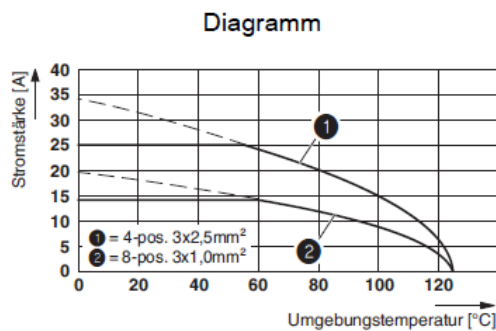

Attenuation:

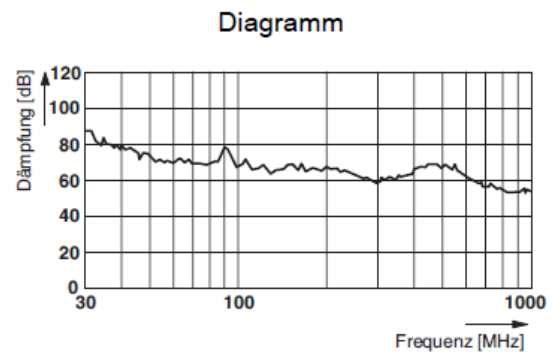

Suitable female contacts (contacts order separately)



Lapp Art. No.	Description
44423122:	Crimpkontakt, machined, Contact diameter: 1 mm, Crimp range: 0,06 mm ² ...0,25 mm ²
44423123:	Crimpkontakt, machined, Contact diameter: 1 mm, Crimp range: 0,34 mm ² ...0,5 mm ²
44423124:	Crimpkontakt, machined, Contact diameter: 1 mm, Crimp range: 0,5 mm ² ...1 mm ²

Suitable male contacts (contacts order separately)



Lapp Art. No.	Description
44423130:	Crimpkontakt, machined, Contact diameter: 1 mm, Crimp range: 0,06 mm ² ...0,25 mm ²
44423131:	Crimpkontakt, machined, Contact diameter: 1 mm, Crimp range: 0,34 mm ² ...0,5 mm ²
44423132:	Crimpkontakt, machined, Contact diameter: 1 mm, Crimp range: 0,5 mm ² ...1 mm ²

44423070	DATA SHEET	
Valid from: 17.09.2018	EPIC® M17 POWER A1	

Version 6+PE

Electrical Characteristics:

Rated Voltage	630 V
Rated Impulse Voltage	6000 V
Rated Current (25°C)	14 A
Contact diameter	1 mm
Termination cross-section	0,06 mm ² - 1,0 mm ²

Pin configuration:

Female

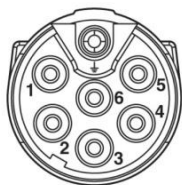

Male

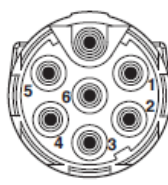

Derating:

Diagramm

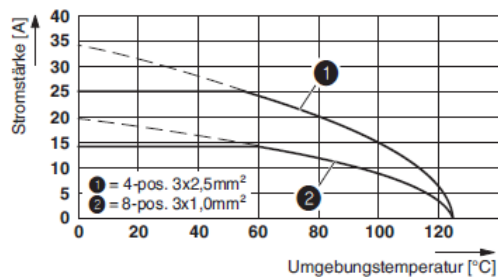

Attenuation:

Diagramm

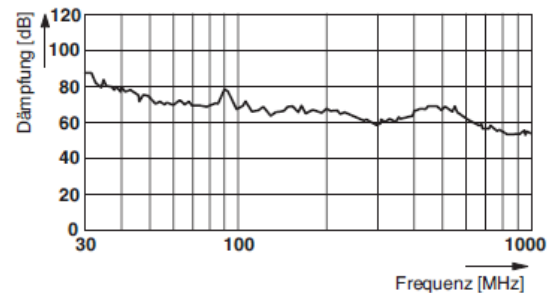

Suitable female contacts (contacts order separately)



Lapp Art. No.	Description
44423122:	Crimpkontakt, machined, Contact diameter: 1 mm, Crimp range: 0,06 mm ² ...0,25 mm ²
44423123:	Crimpkontakt, machined, Contact diameter: 1 mm, Crimp range: 0,34 mm ² ...0,5 mm ²
44423124:	Crimpkontakt, machined, Contact diameter: 1 mm, Crimp range: 0,5 mm ² ...1 mm ²

Suitable male contacts (contacts order separately)



Lapp Art. No.	Description
44423130:	Crimpkontakt, machined, Contact diameter: 1 mm, Crimp range: 0,06 mm ² ...0,25 mm ²
44423131:	Crimpkontakt, machined, Contact diameter: 1 mm, Crimp range: 0,34 mm ² ...0,5 mm ²
44423132:	Crimpkontakt, machined, Contact diameter: 1 mm, Crimp range: 0,5 mm ² ...1 mm ²

Creator: STKU3/PDP Released: IVSE1/PDP	Document: DE44423070EN Version: 01	Page 4 of 7
---	---------------------------------------	-------------

44423070	DATA SHEET	
Valid from: 17.09.2018	EPIC® M17 POWER A1	

Version 7+PE

Electrical Characteristics:

Rated Voltage	630 V
Rated Impulse Voltage	6000 V
Rated Current (25°C)	14 A
Contact diameter	1 mm
Termination cross-section	0,06 mm ² – 1,0 mm ²

Pin configuration:

Female



Male

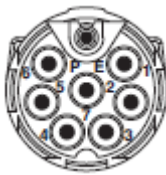

Derating:

Diagramm

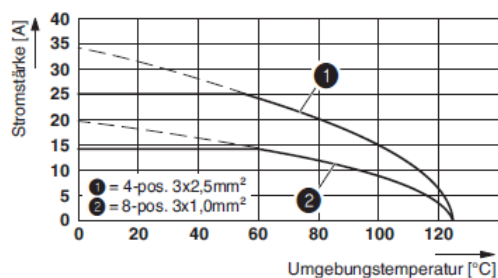

Attenuation:

Diagramm

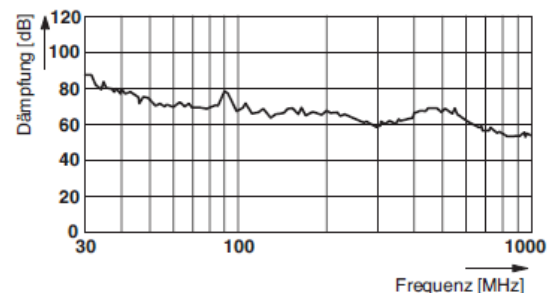

Suitable female contacts (contacts order separately)



Lapp Art. No.	Description
44423122:	Crimpkontakt, machined, Contact diameter: 1 mm, Crimp range: 0,06 mm ² ...0,25 mm ²
44423123:	Crimpkontakt, machined, Contact diameter: 1 mm, Crimp range: 0,34 mm ² ...0,5 mm ²
44423124:	Crimpkontakt, machined, Contact diameter: 1 mm, Crimp range: 0,5 mm ² ...1 mm ²

Suitable male contacts (contacts order separately)



Lapp Art. No.	Description
44423130:	Crimpkontakt, machined, Contact diameter: 1 mm, Crimp range: 0,06 mm ² ...0,25 mm ²
44423131:	Crimpkontakt, machined, Contact diameter: 1 mm, Crimp range: 0,34 mm ² ...0,5 mm ²
44423132:	Crimpkontakt, machined, Contact diameter: 1 mm, Crimp range: 0,5 mm ² ...1 mm ²

Creator: STKU3/PDP Released: IVSE1/PDP	Document: DE44423070EN Version: 01	Page 5 of 7
---	---------------------------------------	-------------

44423070	DATA SHEET	
Valid from: 17.09.2018	EPIC® M17 POWER A1	

Version 3+PE+5

Electrical Characteristics

Rated Voltage
 Rated Impulse Voltage
 Rated Current (25°C)
 Contact diameter
 Termination cross-section

Power / Signal

630 V / 60 V
 6000 V / 1500 V
 14 A / 3, 6 A
 1 mm / 0, 6 mm
 0, 06 mm² – 1, 0 mm² / 0, 08 mm² – 0, 5 mm²

Pin configuration:

Female

Male

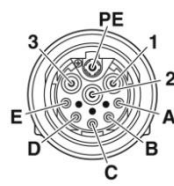
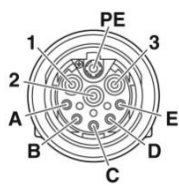

Suitable female contacts (contacts order separately)



Lapp Art. No.	Description
44423122:	Crimpkontakt, machined, Contact diameter: 1 mm, Crimp range: 0, 06 mm ² ...0, 25 mm ²
44423123:	Crimpkontakt, machined, Contact diameter: 1 mm, Crimp range: 0, 34 mm ² ...0, 5 mm ²
44423124:	Crimpkontakt, machined, Contact diameter: 1 mm, Crimp range: 0, 5 mm ² ...1 mm ²
44423125:	Crimpkontakt, machined, Contact diameter: 0,6 mm, Crimp range: 0, 08 mm ² ...0,25 mm ²
44423126:	Crimpkontakt, machined, Contact diameter: 0, 6 mm, Crimp range: 0, 14 mm ² ...0, 34 mm ²
44423127:	Crimpkontakt, machined, Contact diameter: 0, 6 mm, Crimp range: 0, 34 mm ² ...0, 5 mm ²

Suitable male contacts (contacts order separately)



Lapp Art. No.	Description
44423130:	Crimpkontakt, machined, Contact diameter: 1 mm, Crimp range: 0, 06 mm ² ...0, 25 mm ²
44423131:	Crimpkontakt, machined, Contact diameter: 1 mm, Crimp range: 0, 34 mm ² ...0, 5 mm ²
44423132:	Crimpkontakt, machined, Contact diameter: 1 mm, Crimp range: 0, 5 mm ² ...1 mm ²
44423133:	Crimpkontakt, machined, Contact diameter: 0, 6 mm, Crimp range: 0, 08 mm ² ...0, 25 mm ²
44423134:	Crimpkontakt, machined, Contact diameter: 0, 6 mm, Crimp range: 0, 14 mm ² ...0, 34 mm ²
44423135:	Crimpkontakt, machined, Contact diameter: 0, 6 mm, Crimp range: 0, 34 mm ² ...0, 5 mm ²

Creator: STKU3/PDP Released: IVSE1/PDP	Document: DE44423070EN Version: 01	Page 6 of 7
---	---------------------------------------	-------------

44423070	DATA SHEET	
Valid from: 17.09.2018	EPIC® M17 POWER A1	

Technical Drawings and Dimensions:

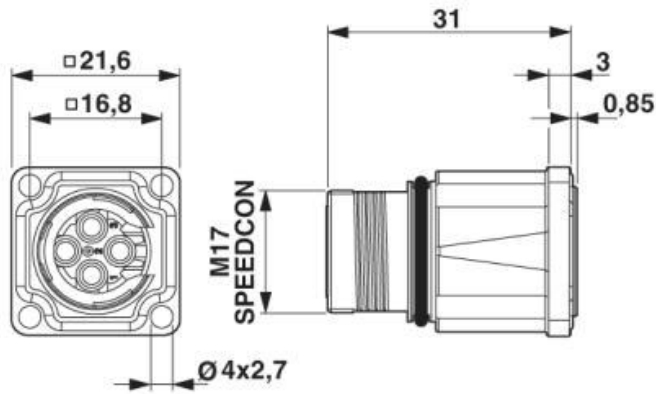

Required holes and openings on the housing:

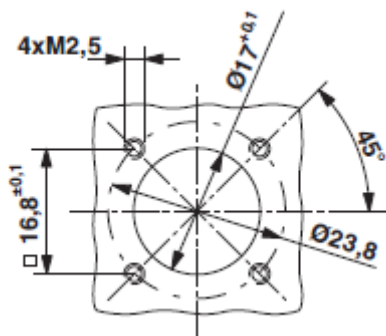

Application range:

Servo drives and servo assemblies
Plant engineering, machinery manufacturing

Remark:

Photographs are not to scale and do not represent detailed images of the respective products.

Creator: STKU3/PDP Released: IVSE1/PDP	Document: DE44423070EN Version: 01	Page 7 of 7
---	---------------------------------------	-------------