

00008747	DATA SHEET	
Valid from: 23.05.2022	EPIC® SIGNAL R 3.0 A	

Description

- Circular connectors with solder termination
- 21-pin and 26-pin
- highest contact density at small space requirements
- Connector in solder version for easy maintenance



General Characteristics

Series	SIGNAL R 3.0 A
Number of contacts	21-pin / 26-pin
Pin configuration	Male E-part / Female P-part
Coding	N
Rated voltage (V)	24V AC / 60VDC
Rated impulse voltage	1,5 kV
Rated current (A)	7,5 A
Contact resistance	< 3 mOhm
Contacts	Copper alloy, gold plated
Termination methods	Solder termination: up to 1.0 mm ²
Fastening type	Ø3,2mm (4x)
Protection	IP 67 (maximum, dependant on cable gland used)
Cycle of mechanical operation	500
Temperature range	-40°C to +100°C, short-term up to +125°C

Materials and Surfaces

Housing	Nickel plated copper alloy
Insert	Thermoplastic
Sealing	Chloroprene Rubber

Versions

Article number	Article description	Version	Contacts	Pin configuration	Fastening type	Coding
00008747	EPIC® SIGNAL R 3.0 A	male	1 - 21	E-Part	Ø3,2mm (4x)	N
00008825	EPIC® SIGNAL R 3.0 A	male	1 - 26	E-Part	Ø3,2mm (4x)	N
00008867	EPIC® SIGNAL R 3.0 A	female	1 - 21	P-Part	Ø3,2mm (4x)	N
00008746	EPIC® SIGNAL R 3.0 A	female	1 - 26	P-Part	Ø3,2mm (4x)	N

Creator: FICE1/PDP Released: VACH1/PDP	Document: DB00008747EN Version: 02	Page 1 of 3
---	---------------------------------------	-------------

00008747	DATA SHEET	
Valid from: 23.05.2022	EPIC® SIGNAL R 3.0 A	

Technical Drawings

Housing

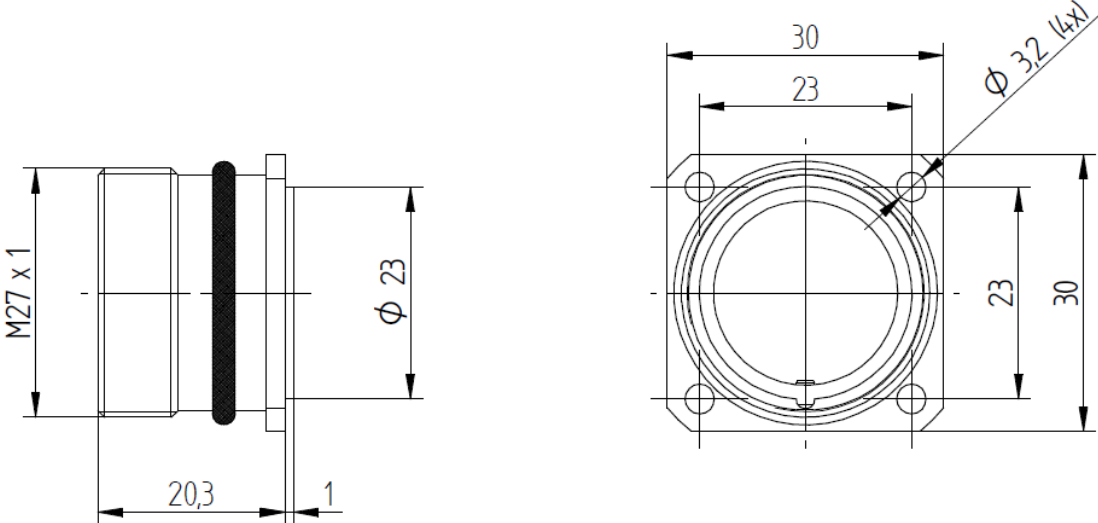

Inserts (plug-side view)

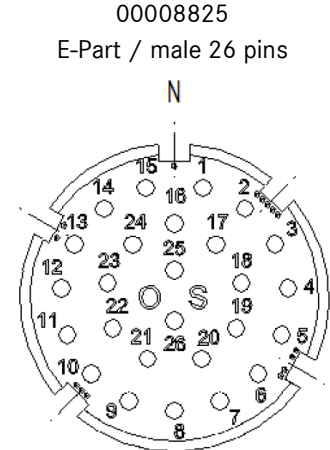
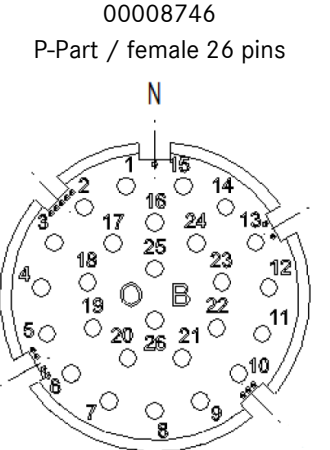
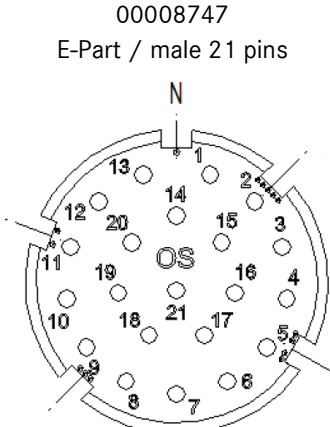
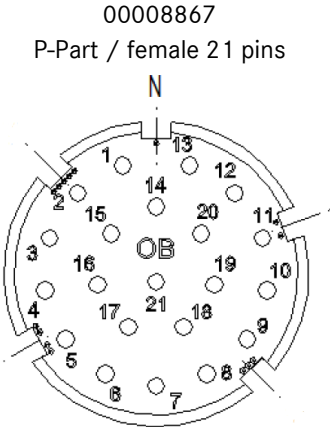

00008747	DATA SHEET	
Valid from: 23.05.2022	EPIC® SIGNAL R 3.0 A	



Corrosion-resistant



Industrial machinery and plant engineering



Mechanical resistance



Space requirement

Application range

Machine and equipment manufacturing

Measurement and control technology

Remark

Photographs are not to scale and do not represent detailed images of the respective products.

Creator: FICE1/PDP Released: VACH1/PDP	Document: DB00008747EN Version: 02	Page 3 of 3
---	---------------------------------------	-------------